





**i**





 x1

 4 min

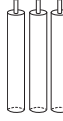

 [www.my-unilux.com](http://www.my-unilux.com)

**+**

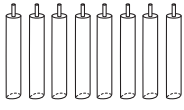
<b>(A)</b>	<b>(B)</b>	<b>(C)</b>	<b>(D)</b>	<b>(E)</b>	<b>(F)</b>
					
x1	x3	x1	x1	x1	x8

**1**

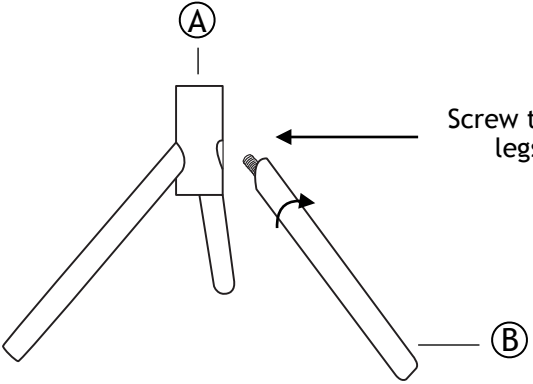

Screw the 3 legs

**2**

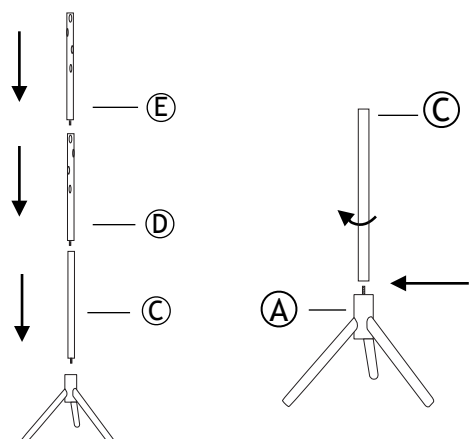

Screw the 3 parts to create the Coat-stand body.

**3**

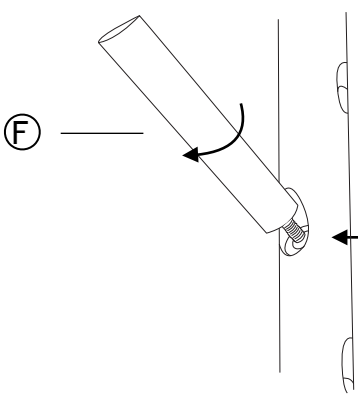

Screw the 8 pegs

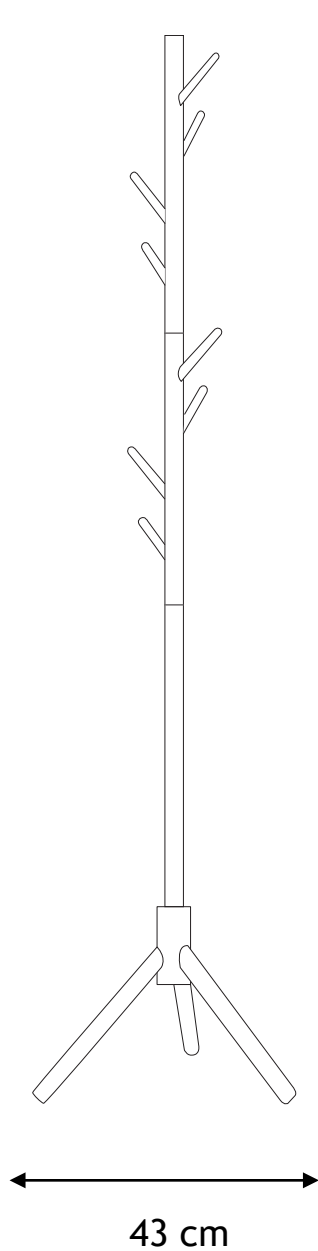

174 cm

43 cm