





i

 x1

 5 min





 www.my-unilux.com

+

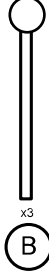
 x1 (A)

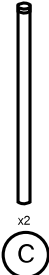
 x3 (B)

 x2 (C)

 x3 (D)

 x1 (E)

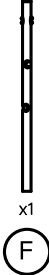
 x1 (F)

 x1 (G)

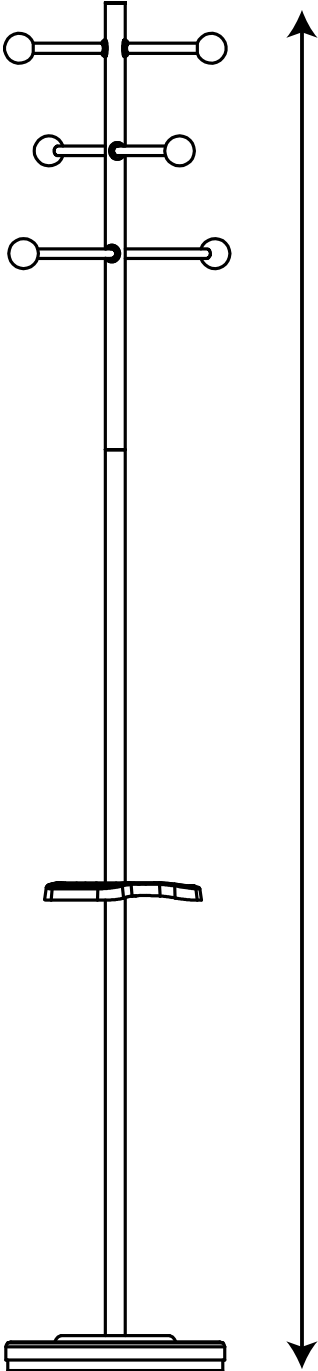

174 cm

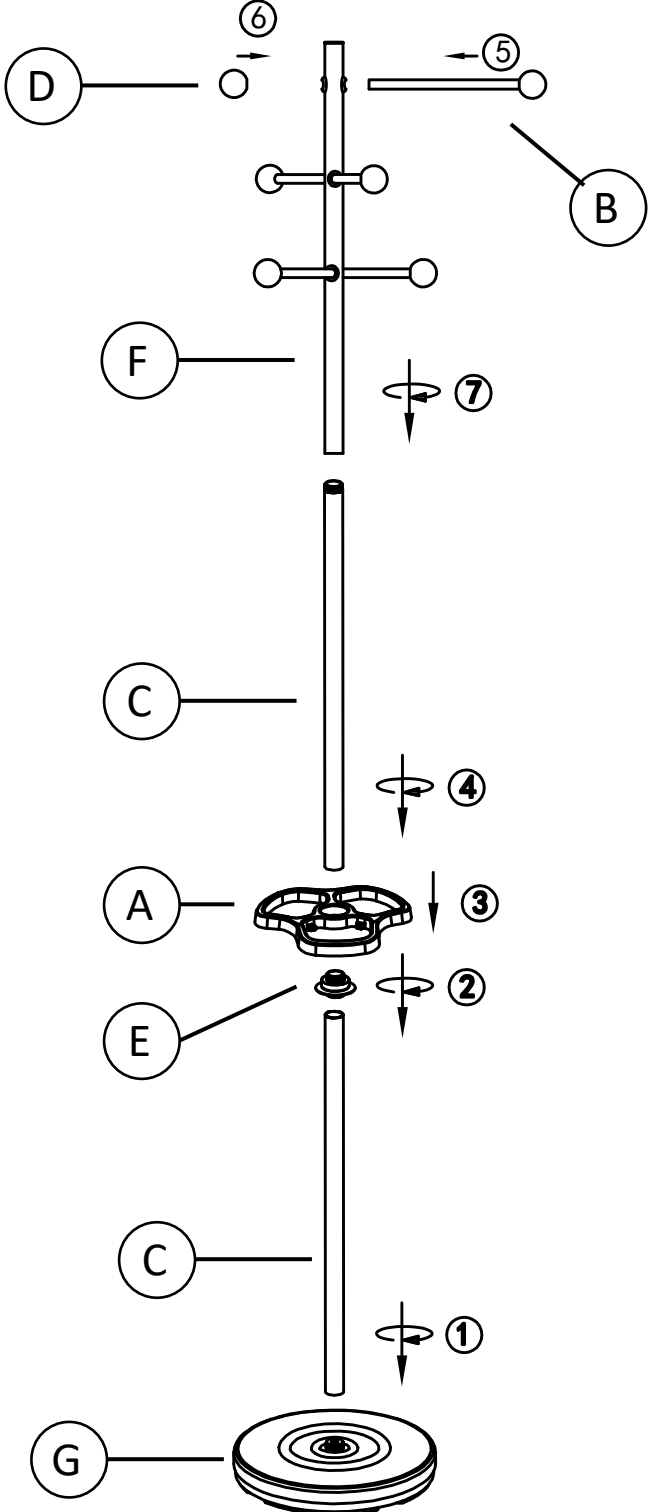

①

②

③

④

⑤

⑥

⑦