



UNILUX

AMBIANCE LUMI

AMBIANCE LUMI



AMBIANCE LUMI



- **Ideal for reception and reception areas:** put a touch of color while creating a cozy lighting atmosphere.
- **Sober design:** the thinness of its mast and the conical shape of its lampshade gives this table lamp a timeless design.
- **Soft light:** the lampshade is made of heat-resistant fabric that is easy to clean, the light is pleasant for the eyes.
- **Energetically efficient:** comes with an 11W E27 bulb, this floor lamp consumes 75% less energy than incandescent lighting and 35% less energy than fluorescent lighting for the same level of brightness.
- **Available in 5 colours:** blue, white, red, orange and green. Put a touch of color.
- **ON/OFF switch:** easy access on the cord.

Warranty: 2 years
 Height: 155 cm
 Materials: metal base and arm with epoxy paint / fabric lampshade.



End user replaceable light source (LED only)

Characteristics

Measurement in Lux on the worktop
 in view of below at 35cm

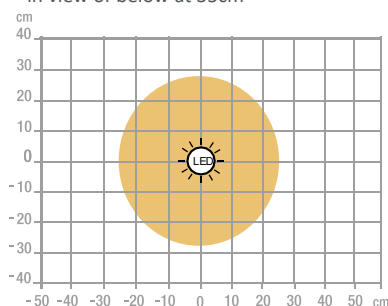

Measurement in Lux on the worktop
 in profile view at 35cm

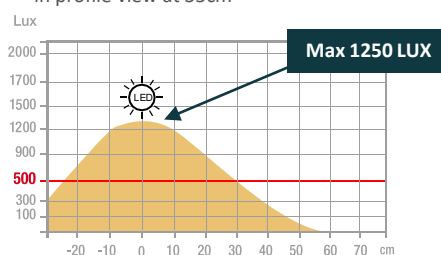

Measurement in nanometers
 of the light spectrum

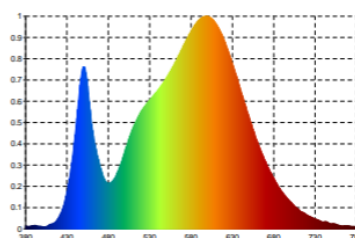

- 0 No-risk
- 1 Low-risk
- 2 Moderate-risk
- 3 High-risk

SAP. code	400166581	400166582	400166583	400166584	400166585
EAN code	3595560036189	3595560036202	3595560036226	3595560036240	3595560036264
Colors	White	Blue	Orange	Red	Green
Luminous flow (Lm)	915	915	915	915	915
Lux at 35 cm in direct (Lx)	1250	1250	1250	1250	1250
Luminous Efficiency (Lm/W)	83	83	83	83	83
Color T°(K)	3000	3000	3000	3000	3000
CRI	84	84	84	84	84
Source's lifetime (h)	30 000	30 000	30 000	30 000	30 000
Energy Consumption (kWh/1000h)	11	11	11	11	11
Net weight (kg)	4,75	4,75	4,75	4,75	4,75

OUR CSR COMMITMENTS

1. All our lighting are **100% repairable** thus limiting planned obsolescence.
2. Reduce our carbon footprint through our **ECO-DESIGN THINKING** approach.
3. Contribute to the preservation of the planet's natural resources by promoting the use of **recycled materials**.
4. Optimize our packaging to control our **transport costs**.
5. Highlight the **talent of our employees** by ensuring social equality.

Energy class

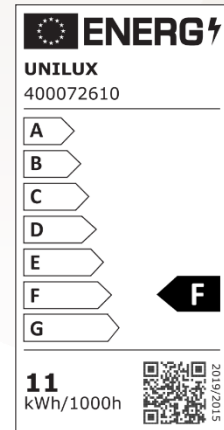

OUR EXPERTISE

1- Floor lamp with direct and indirect lighting: the ideal and optimal lighting on your desk

The right lighting activates and motivates, it stimulates concentration and performance. Poor work lighting quickly causes health problems like muscle aches, headaches, and eye strain as the body tries to compensate for poor visual conditions. Improve the result by adapting the lighting to individual needs on the workstation. The more difficult the visual task, the higher the illumination must be. 34% of offices reach the level of illumination of 500 Lux prescribed by occupational medicine. Installing a lamp with direct and indirect lighting on your workstation allows you to adapt the lighting according to the activity (reading, writing, data processing, etc.), limit glare and reduce the areas contrasts that cause eye strain.

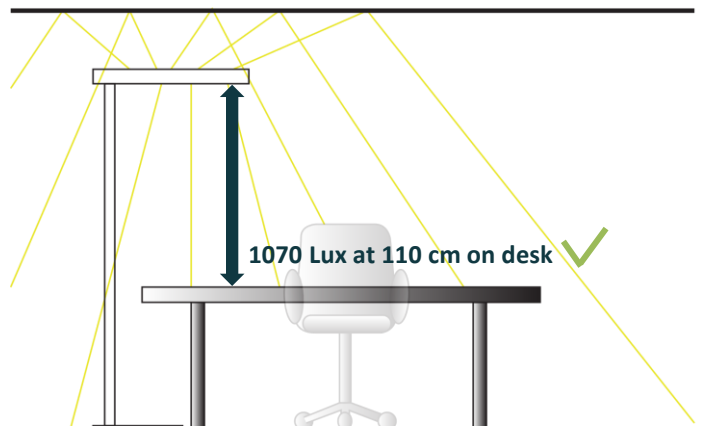

Lighting according to DIN EN 12464-1 * for the office

- **300 Lux:** deposit, copy, circulation areas
- **500 Lux:** writing, reading, data processing
- **500 Lux:** at the reception and at the counter
- **750 Lux:** technical drawing

OUR CERTIFICATIONS

Unilux is committed to an eco-responsible approach and ensures that its products respect this commitment. Indeed, we are very concerned about current environmental issues and we aspire to respond as best as possible to the concerns of our consumers on this subject. Sustainable development is at the heart of our strategy and we act for the environment. You will find below the different certifications that Unilux has and that prove its environmental commitment.



UNILUX

* DIN EN 12464-1 (DIN 5035-1): European standard which determines the lighting requirements for workstations in closed places, these satisfying the needs of comfort and visual performance. DIN EN 12464-1 replaced DIN 5035-1

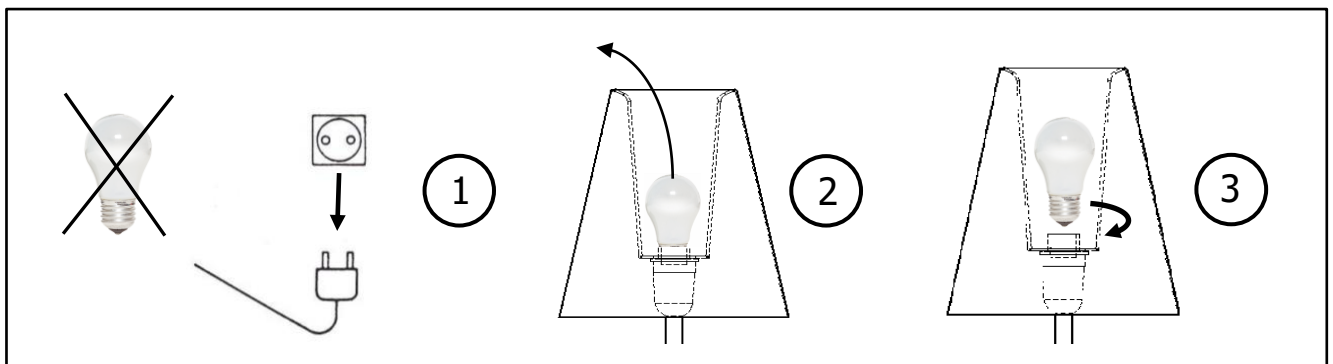
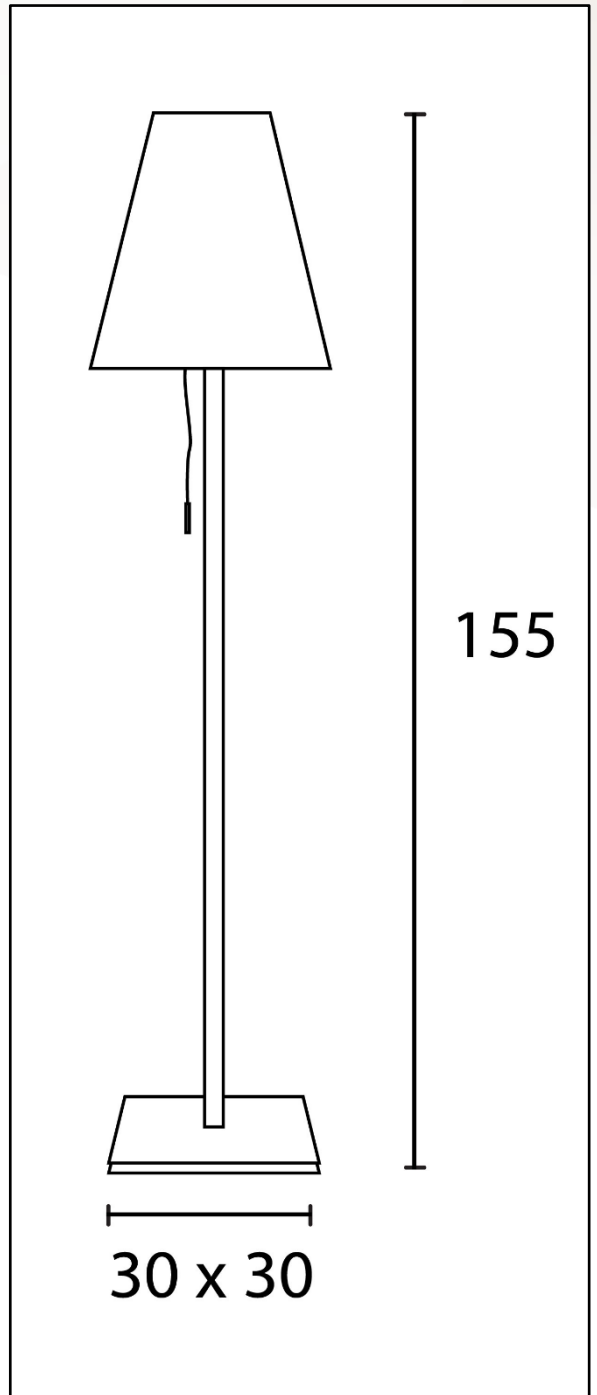
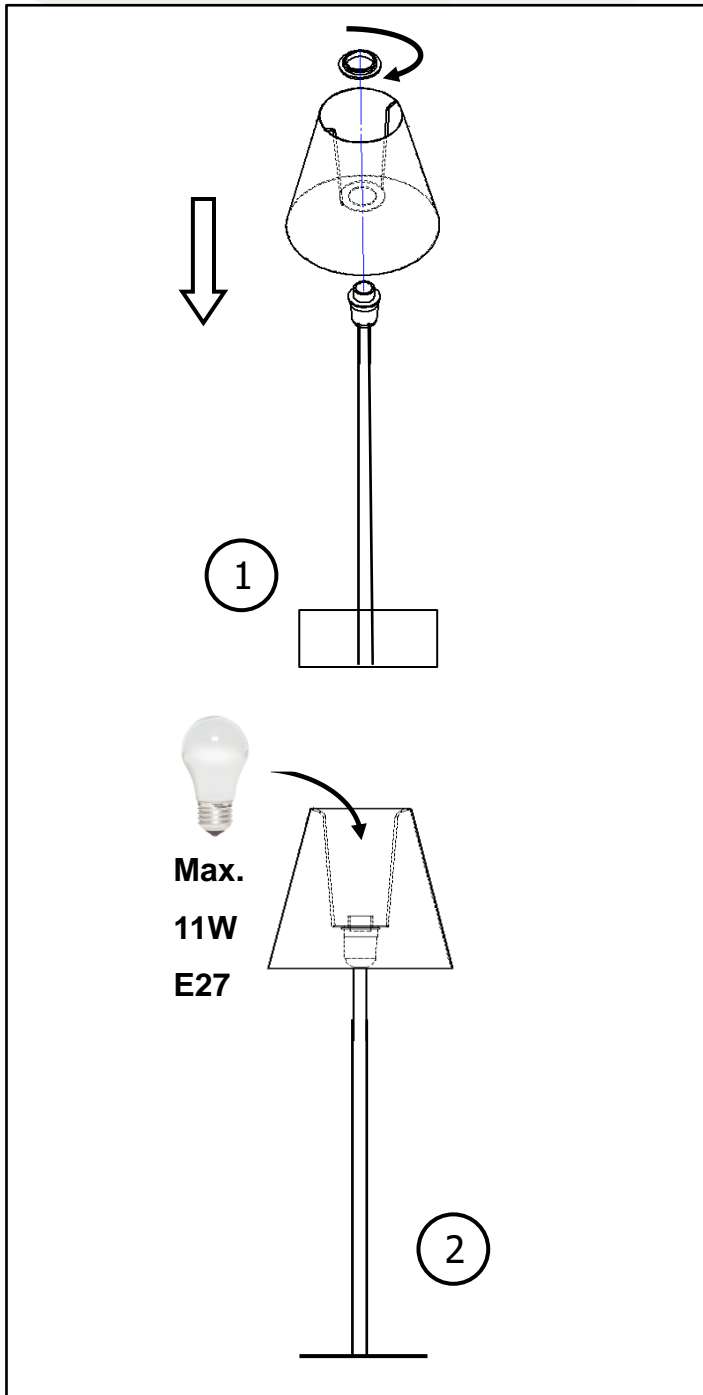

30 products available on pCon Planner

You will be able to obtain data on many UNILUX or OFML standard products and integrate them quickly and easily into 3D space layouts via pCon.



Download on our E-shop

Always available: photos in HD, data sheets, instruction manual, repairability instructions for all our products.



Do you have any questions?

Our after-sales service is always at your disposal

Tèl: +33 1 81 86 06 03

E-mail: contact.unilux@hamelinbrands.com

17 avenue du Parc TECHNOPOLES

91380 Chilly Mazarin – France

Tèl: +33 1 81 86 06 00

www.my-unilyx.com

E-mail: contact.unilux@hamelinbrands.com

UNILUX