



UNILUX

ERGO BOOST

ERGO BOOST



- Fight against a sedentary lifestyle: sitting increases the risk of heart problems and reduces life expectancy by 7 years. Indeed, the human body is designed to “move”, not to stay in a stationary position for 9 hours a day.
- Well-being: promotes a dynamic posture while stabilizing the movement thanks to its innovative concept of its “diamond” pointed base. This base design allows you to stabilize your position and thus adopt the correct posture without hindering your movements.
- Ergonomic: ideal for avoiding back, lumbar and muscle pain (shoulders, arms, back). Thanks to the perfect alignment of the spine, the whole body “benefits”.
- Ergonomic and comfortable seat: curved circular seat in padded foam (6 cm thick) in high-density fabric for optimal comfort and well-being (width 34 cm).
- Variable adjustment: easily adjustable height (55-70 cm) thanks to its gas lift system and its 2 easy-access adjustment handles located under the seat. In the low position, it will allow you to have the right posture even with a standard height desk.
- Complementary products: It is recommended to use with the HOMY folding desk or the ERGO WELL electric lifting desk.

Height: 55 cm to 70 cm
 Assembly time: 3 minutes
 Reasonable weight: 5.36 kg
 Load capacity: can support a weight up to 120 kg
 Materials: metal tube with white epoxy paint / plastic and rubber base / fabric seat

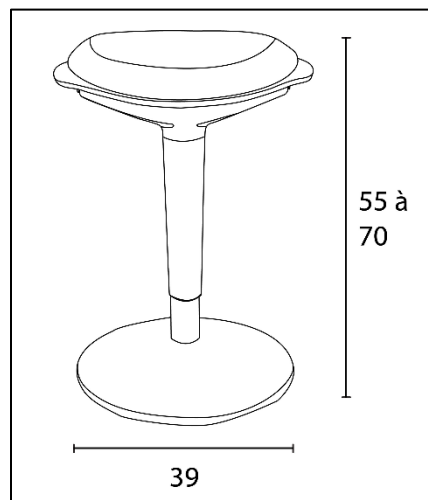

Characteristics

SAP no.	400165092
Color	White/Grey
Dimensions	38 x 55-70 x 34 cm
Warranty	2 years
Net weight	5,36 kg
EAN code	3595560034604

OUR CSR COMMITMENTS

1. All our lighting are **100% repairable** thus limiting planned obsolescence.
2. Reduce our carbon footprint through our **ECO-DESIGN THINKING** approach.
3. Contribute to the preservation of the planet's natural resources by promoting the use of **recycled materials**.
4. Optimize our packaging to control our **transport costs**.
5. Highlight the **talent of our employees** by ensuring social equality.

OUR EXPERTISE

Combating a sedentary lifestyle

Following numerous studies, sitting will increase the risk of having heart problems while reducing life expectancy by 7 years. Indeed, the human body is designed to “move”, and not to remain almost still for 9 hours a day. Ultimately, this position disrupts the entire body (less well oxygenated) which leads to an increase in fat cells causing potential excess weight. Ideal for avoiding back, lumbar and muscular pain (shoulders, arms, back), our range of dynamic seats is designed to promote good posture in your spine by inducing the tilt of your pelvis and forming an open angle of 110° between your thighs and your spine, thereby reducing the tension exerted on your pelvic muscles. This natural posture prevents back pain and improves your muscle tone without hindering your movements.

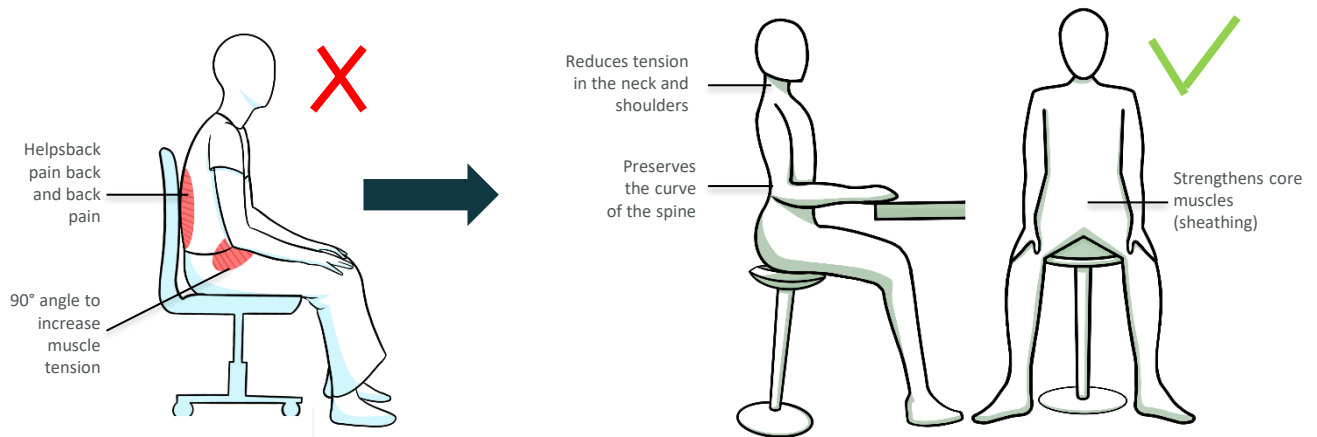

OUR CERTIFICATIONS

Unilux is committed to an eco-responsible approach and ensures that its products respect this commitment. Indeed, we are very concerned about current environmental issues and we aspire to respond as best as possible to the concerns of our consumers on this subject. Sustainable development is at the heart of our strategy and we act for the environment. You will find below the different certifications that Unilux has and that prove its environmental commitment.



USER GUIDE



x1



3 min



www.my-unilux.com

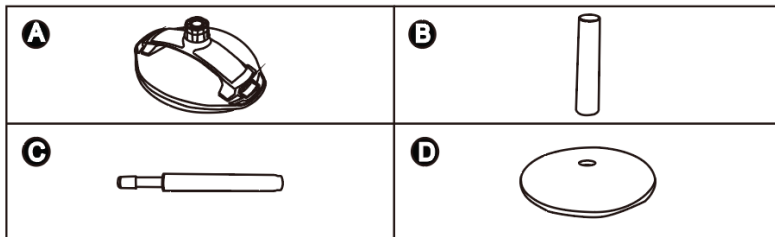

1

Remove & discard the plastic cap covering the tip of the gas spring.

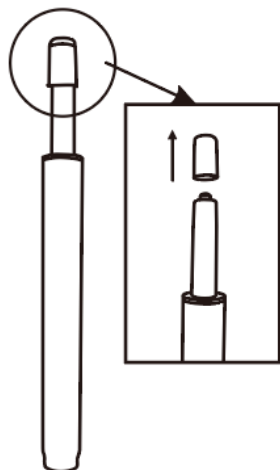

2

Insert the gas spring (C) into the base (D). Once aligned correctly, press down firmly.

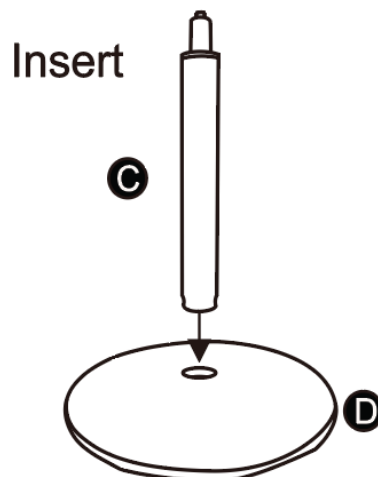

3

Attach the Plastic Collar (B) to the Seat (A) by resting the Seat on the cushion and firmly pressing the Plastic Tube against the seat.

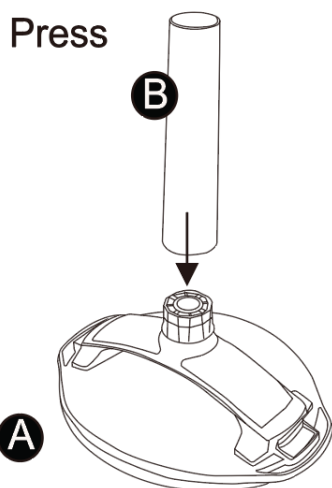

4

Gently slide the seat onto the gas spring. Once aligned properly, press down firmly on the seat.

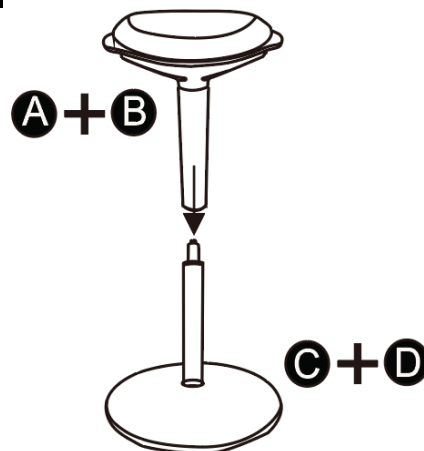

WARNING!
The Plastic Cap must be removed before use. Failure to remove it will lead to malfunction.

30 products available on pCon Planner

You will be able to obtain data on many UNILUX or OFML standard products and integrate them quickly and easily into 3D space layouts via pCon.



Download on our E-shop

Always available: photos in HD, data sheets, instruction manual, repairability instructions for all our products.



Do you have any questions?

Our after-sales service is always at your disposal

Tèl: +33 1 81 86 06 03

E-mail: contact.unilux@hamelinbrands.com

17 avenue du Parc TECHNOPOLES

91380 Chilly Mazarin – France

Tèl: +33 1 81 86 06 00

www.my-unilyx.com

E-mail: contact.unilux@hamelinbrands.com

UNILUX