



UNILUX

TAMY

TAMY



TAMY comes in 5 different colors and has a flexible part at the top of the arm that makes it easy to orient the head in all directions.

Lamp that combines sobriety and modernity, the shape of the head promotes a wide diffusion on the worktop.



- **Flexible and Stable:** Its flexible arm can rotate 360°. You can easily adjust the direction of the lighting towards your work area; the weighted base provides excellent stability.
- **Modern and sober design:** its head shape promotes a wide diffusion of light on the worktop.
- **Pleasant light:** stable and quality light thanks to the latest generation LEDs. In addition, these LEDs are protected by an opaque diffuser: no flickering, no glare.
- **Energy Efficient:** This lamp uses 75% less energy than incandescent lighting and 35% less energy than fluorescent lighting for the same level of brightness.
- **Available in 5 colors:** blue, white, green, pink, black. Put a splash of color on your desk.
- **ON/OFF switch:** easily accessible on the cord

Warranty : 2 years

Maximum height: 33 cm / minimum height: 20 cm

Materials: ABS plastic head and base / rubberized surface metal arms



Professional replaceable light source (LED only)

Characteristics

Lux measurement on the work surface in top view at 35 cm:

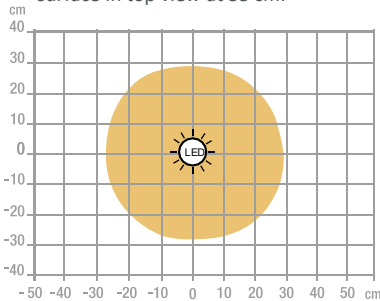

> 500 Lux

< 500 Lux

Measurement in Lux on the worktop in profile view at 35 cm:

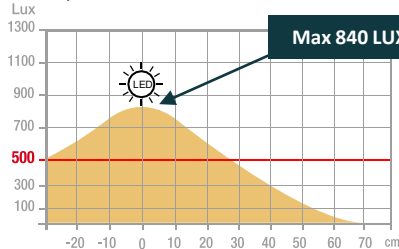

Max 840 LUX

Measurement in nanometers of the light spectrum

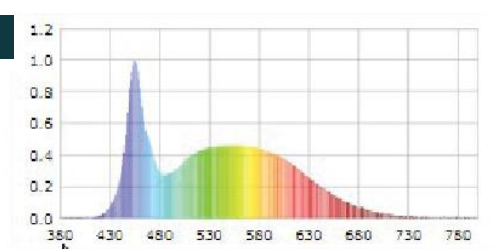

- 0 No-risk
- 1 Low-risk
- 2 Moderate-risk
- 3 High-risk

SAP no.	400165012	400172506	400165015	400165017	400165986	400165018
EAN code	3595560034284	3595560037742	3595560034314	3595560034345	3595560035007	3595560034376
Colors	White	Black	Green	Blue	Light Grey	Pink
Luminous flow	625	625	625	625	625	625
Lux at 35cm	840 cm	840 cm	840 cm	840 cm	840 cm	840 cm
Lm/W	104	104	104	104	104	104
Color T* (K)	3000	3000	3000	3000	3000	3000
CRI	84	84	84	84	84	84
Source Lifetime (h)	20 000	20 000	20 000	20 000	20 000	20 000
Energy consumption (kWh/1000 h)	6	6	6	6	6	6
USB Port	No	No	No	No	No	No
Inductive charger	No	No	No	No	No	No
Net weight (kg)	0,80	0,80	0,80	0,80	0,80	0,80

OUR CSR COMMITMENTS

1. All our lighting are **100% repairable** thus limiting planned obsolescence.
2. Reduce our carbon footprint through our **ECO-DESIGN THINKING** approach.
3. Contribute to the preservation of the planet's natural resources by promoting the use of **recycled materials**.
4. Optimize our packaging to control our **transport costs**.
5. Highlight the **talent of our employees** by ensuring social equality.

Energy class

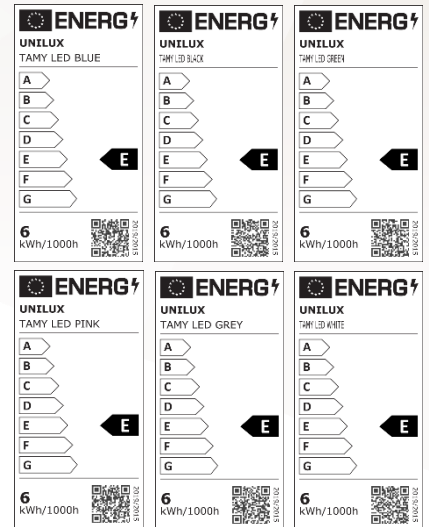

OUR EXPERTISE

1-Why use auxiliary lighting?

We are regularly subjected to constant artificial lighting in the office, which takes no account of our biological rhythms. Poor lighting quality can cause headaches, sleep disorders and loss of concentration. According to a recent study, only 34% of offices achieve the level of illumination of 500 lux recommended by Occupational Medicine in accordance with DIN EN 12464-1*.

2-How to light your workspace?

- Position the lamp head at least 35 cm above the worktop. work surface.
- Place the lamp on the opposite side to the hand that is holding the mouse or writing.
- Use lamps with asymmetrical lighting to reduce eyestrain, which can lead to eye irritation, headaches, loss of concentration, reduced productivity, etc.
- Position the lamp so that it is easy to adjust and so that the light is in the right place.
- Avoid reflections from shiny surfaces.
- Limit direct glare from bright light in the field of vision and indirect glare from the reflection of light from the reflection of light in the field of vision, on a work surface walls or objects.

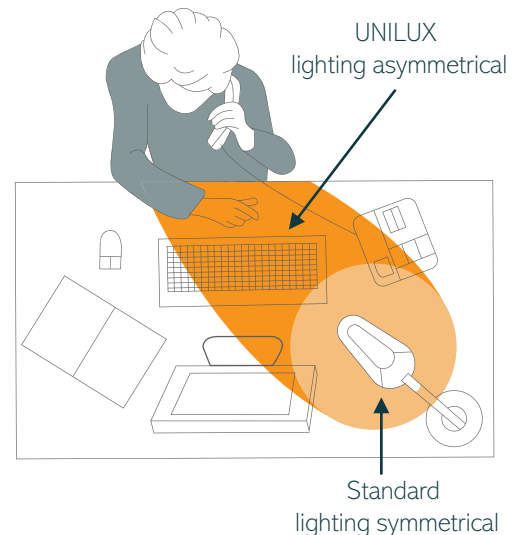

OUR CERTIFICATIONS

Unilux is committed to an eco-responsible approach and ensures that its products respect this commitment. Indeed, we are very concerned about current environmental issues and we aspire to respond as best as possible to the concerns of our consumers on this subject. Sustainable development is at the heart of our strategy and we act for the environment. You will find below the different certifications that Unilux has and that prove its environmental commitment.



UNILUX

*DIN EN 12464-1 (DIN 5035-1): European standard which determines the lighting requirements for workstations in closed places, these satisfying the needs of comfort and visual performance. DIN EN 12464-1 replaced DIN 5035-1

USER GUIDE

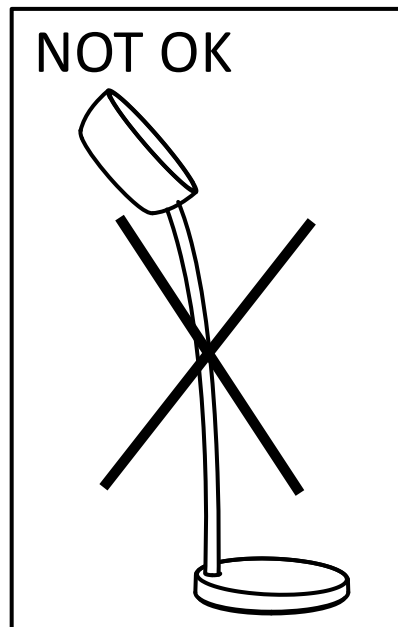
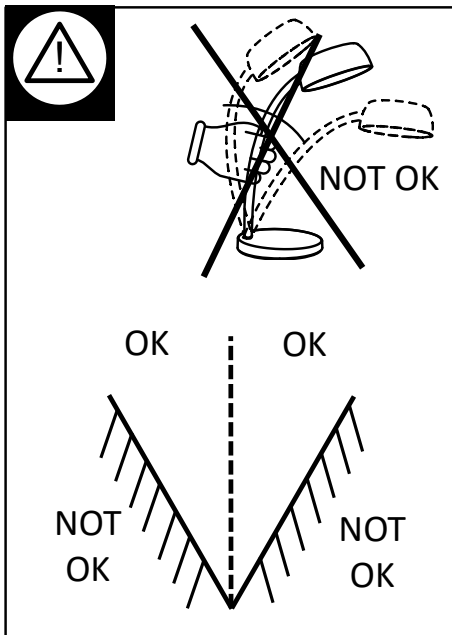
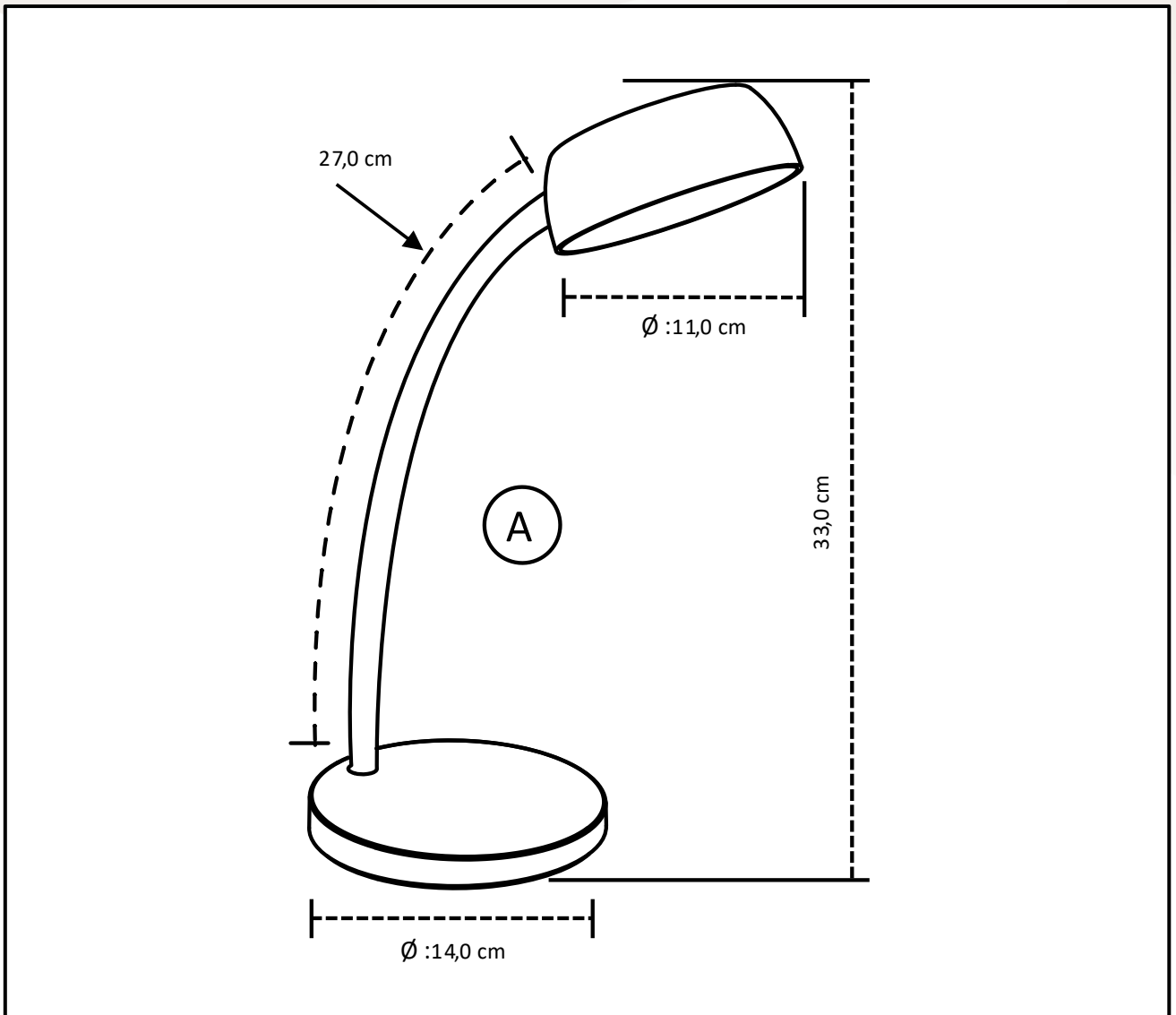

30 products available on pCon Planner

You will be able to obtain data on many UNILUX or OFML standard products and integrate them quickly and easily into 3D space layouts via pCon.



Download on our E-shop

Always available: photos in HD, data sheets, instruction manual, repairability instructions for all our products.



Do you have any questions?

Our after-sales service is always at your disposal

Tèl: +33 1 81 86 06 03

E-mail: contact.unilux@hamelinbrands.com

17 avenue du Parc TECHNOPOLIS

91380 Chilly Mazarin – France

Tèl: +33 1 81 86 06 00

www.my-unilyx.com

E-mail: contact.unilux@hamelinbrands.com

UNILUX