



UNILUX

---

STRATA

# STRATA black

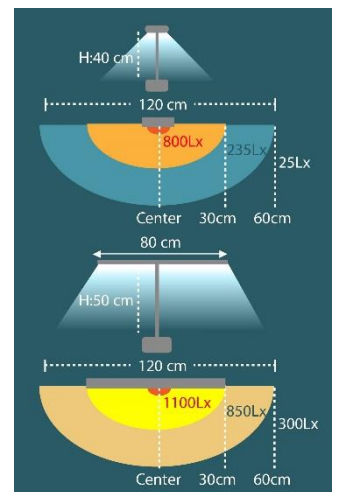

**STRATA** is a beautiful lamp with a long head (80 cm) to illuminate a large office area. It is ideally positioned behind computer screens. Its flexible arm and head articulation facilitate the positioning of the light according to the height of your screens.

It is equipped with many features: touch switch, outdoor light sensor (adapts the light according to the external input), variation of the intensity and ambient color temperature of your workspace, the lamp adapts its light intensity for better visual comfort, thanks to its brightness sensor.



# STRATA white

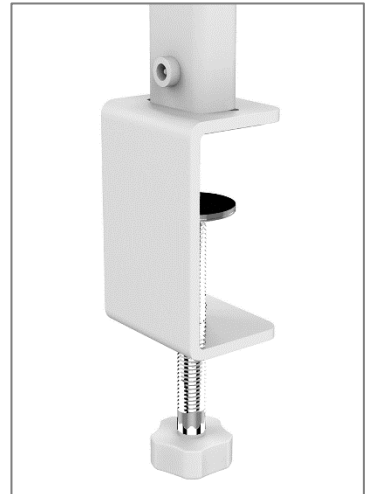
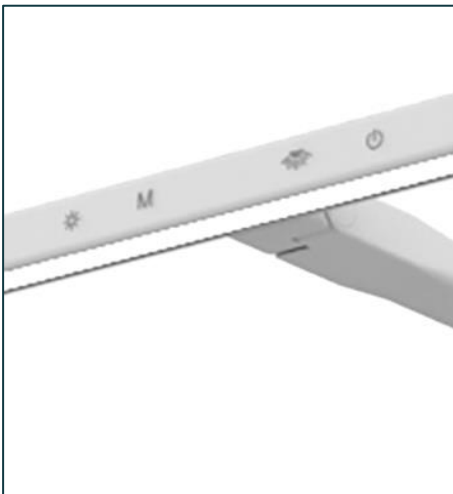



- **Asymmetrical lighting:** equipped with asymmetrical lighting that neutralizes much of the glare and greatly increases the illuminated area.
- **Innovation:** a new generation of ergonomic desk lamp that offers a wide range of light, quality custom lighting and reduces eye fatigue.
- **Optimal visual comfort:** thanks to its flexible arm STRATA adapts to the height and size of your screens.
- **Modern design lamp:** its innovative, slender, airy and refined shape will sublimate your office space.
- **Variation of light intensity and color temperature:** on its head, four touch buttons allow you to vary the light intensity and adjust the color temperature. Adapt your lighting according to your activity (rest, reading, work).
- **Smart:** depending on the ambient light in your workspace, the lamp adapts its light intensity for better visual comfort, thanks to its brightness sensor.

- Warranty: 2 years
- Max height: 70 cm/ minimum height: 40 cm
- Materials: steel clamp (max spacing 7.5 cm)/ aluminum and metal arm with rubberized surface/ aluminum and ABS plastic head



Professional replaceable light source (LED only)

## Characteristics

Measurement of Lux on the worktop in 40 cm top view:

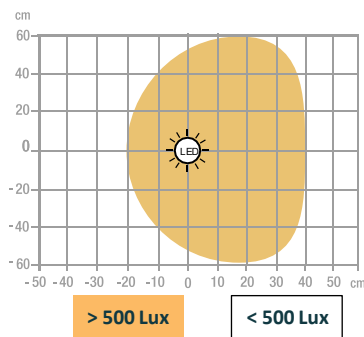

Measurement of Lux on the worktop in 40 cm profile view:

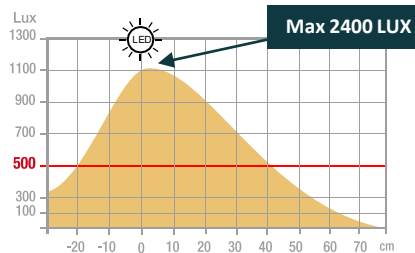

Measurement in nanometers of the light spectrum

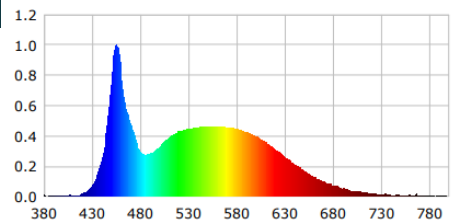

- 0 No-risk
- 1 Low-risk
- 2 Moderate-risk
- 3 High-risk

SAP. code	400124562	400165231
EAN code	3595560029525	3595560034963
Colors	Black	White
Luminous flow (Lm)	2046	2046
Lux (Lx)	2400 à 40 cm	2400 à 40 cm
Luminous Efficiency (Lm/W)	108	108
Color T°( K)	3000/4000/5000/6500	3000/4000/5000/6500
CRI	85	85
Source's lifetime (h)	50 000	50 000
Energy Consumption (kWh/1000h)	19	19
USB port	No	No
Induction charger	No	No
Net weight (kg)	1,25	1,25

# OUR CSR COMMITMENTS

1. All our lighting are **100% repairable** thus limiting planned obsolescence.
2. Reduce our carbon footprint through our **ECO-DESIGN THINKING** approach.
3. Contribute to the preservation of the planet's natural resources by promoting the use of **recycled materials**.
4. Optimize our packaging to control our **transport costs**.
5. Highlight the **talent of our employees** by ensuring social equality.

## Energy class

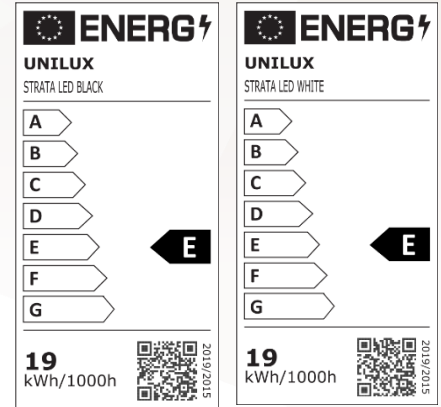

# OUR EXPERTISE

## Asymmetrical lighting: reduce eyestrain!

A desk lamp with symmetrical lighting distributes the light evenly over the work surface. This can be an advantage for conference tables, shops and reception areas. However, when you move your gaze from a brightly lit area to a dark one, your pupil will contract and then dilate, causing eye strain that can translate into tingling eyes and headaches. To prevent this, we recommend an asymmetrically illuminated lamp.

It uses internal reflectors to direct the light so that it shines on a larger surface area. This makes it possible to illuminate the keyboard and work documents in front of your screen without causing unpleasant reflections or glare on the screen, while limiting light contrasts, which are sources of eye fatigue.

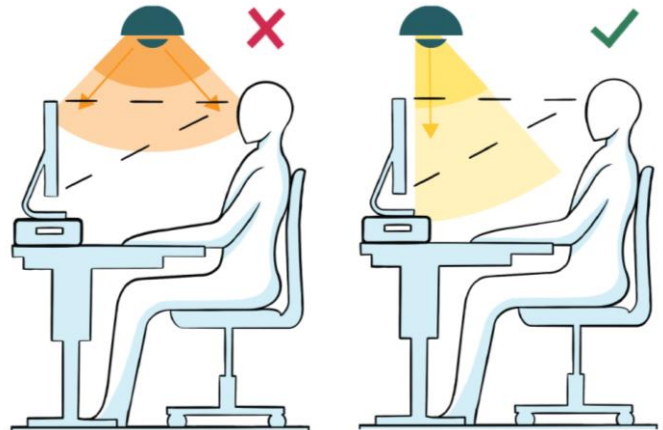

# OUR CERTIFICATIONS

Unilux is committed to an eco-responsible approach and ensures that its products respect this commitment. Indeed, we are very concerned about current environmental issues and we aspire to respond as best as possible to the concerns of our consumers on this subject. Sustainable development is at the heart of our strategy and we act for the environment. You will find below the different certifications that Unilux has and that prove its environmental commitment.



# USER GUIDE

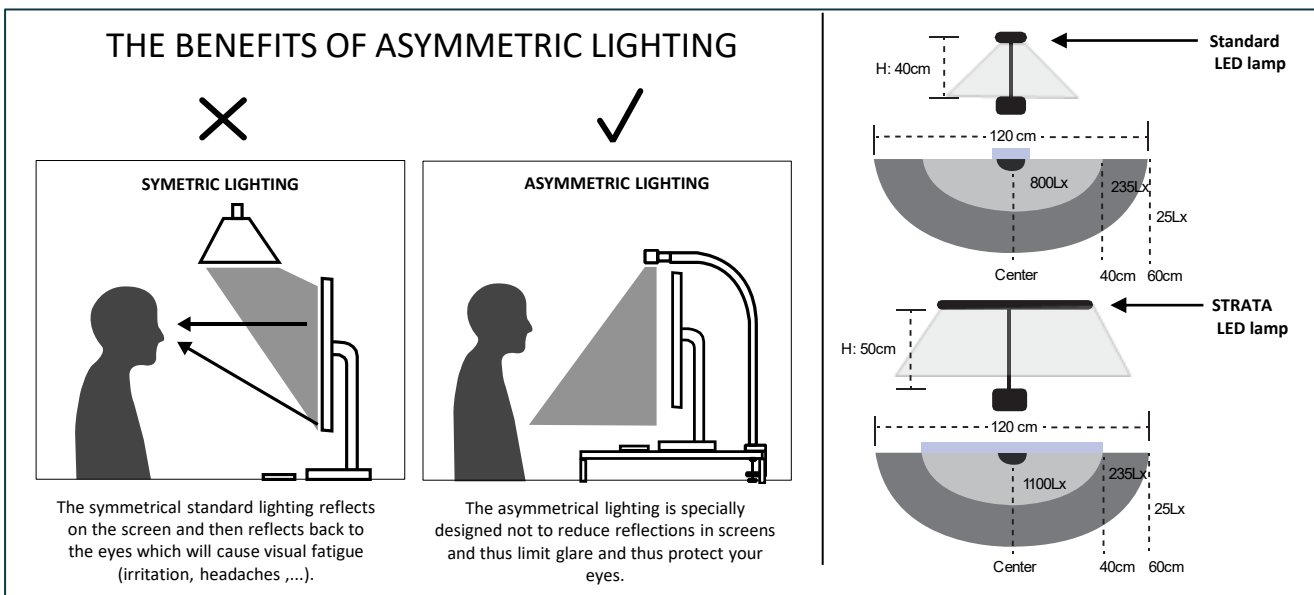
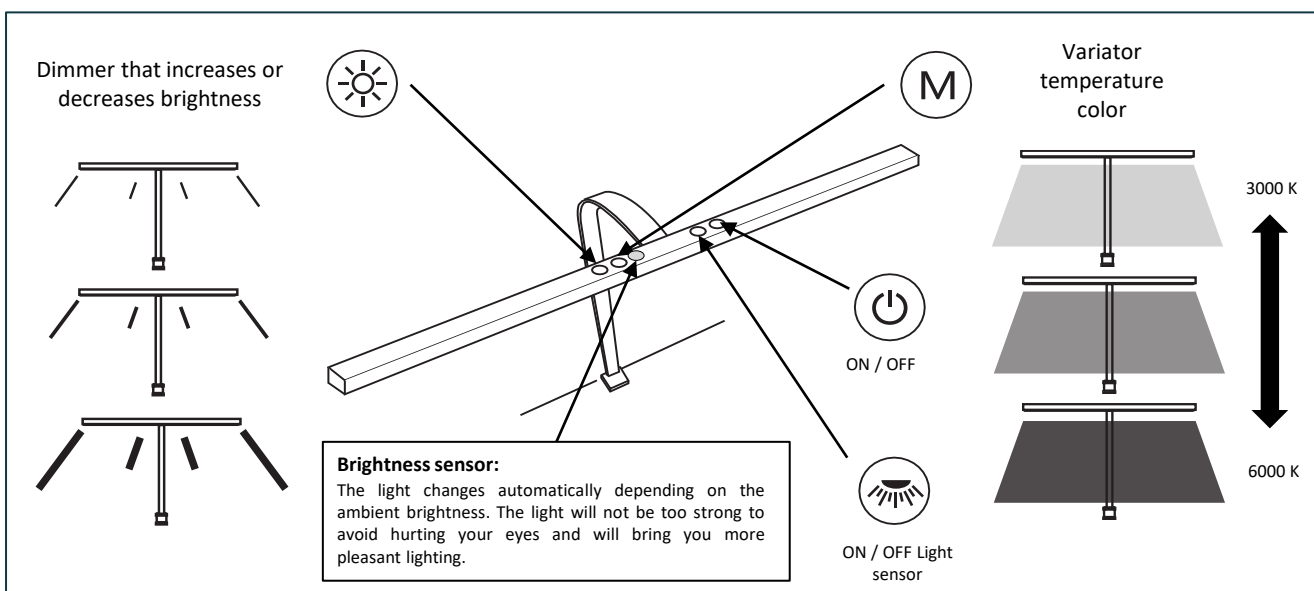
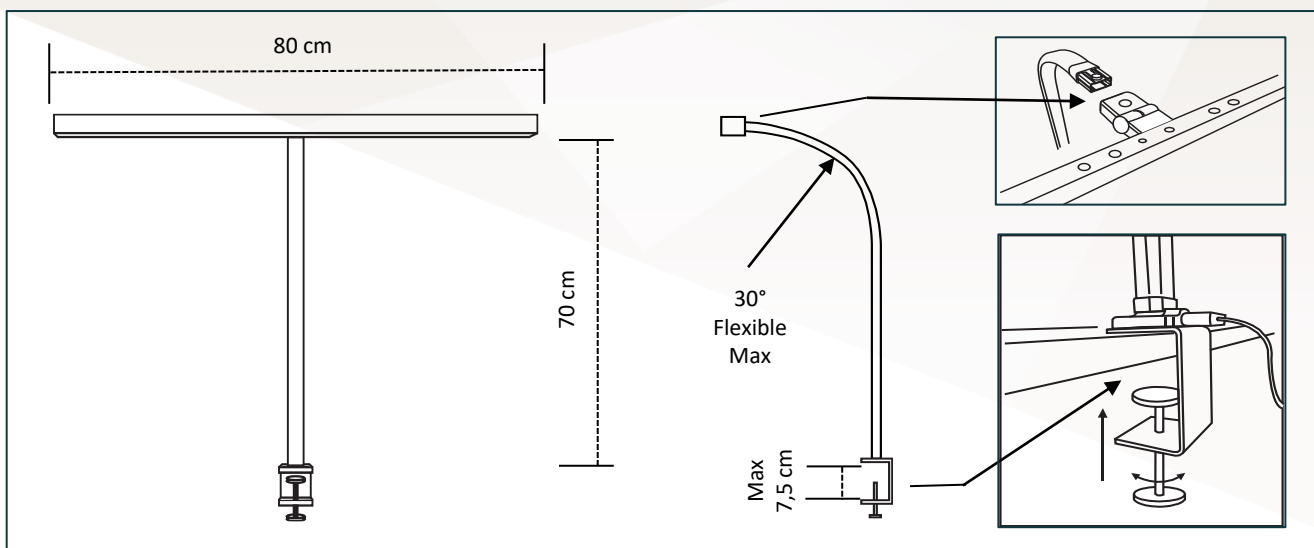

## 30 products available on pCon Planner

You will be able to obtain data on many UNILUX or OFML standard products and integrate them quickly and easily into 3D space layouts via pCon.



## Download on our E-shop

Always available: photos in HD, data sheets, instruction manual, repairability instructions for all our products.



## Do you have any questions?

Our after-sales service is always at your disposal

Tèl: +33 1 81 86 06 03

E-mail: [contact.unilux@hamelinbrands.com](mailto:contact.unilux@hamelinbrands.com)

17 avenue du Parc TECHNOPOLIS

91380 Chilly Mazarin – France

Tèl: +33 1 81 86 06 00

[www.my-unilyx.com](http://www.my-unilyx.com)

E-mail: [contact.unilux@hamelinbrands.com](mailto:contact.unilux@hamelinbrands.com)

UNILUX