



UNILUX

FLEXIO 2

FLEXIO 2 black



FLEXIO 2.0 is supplied with a bulb with very low power consumption. Its lampshade is covered inside with an enamelled paint for a better reflection of light. FLEXIO 2.0, the lamp with a slender and dynamic design, can be swivelled in all directions thanks to its flexible arm.

FLEXIO 2 metal grey



FLEXIO 2.0 is supplied with a bulb with very low power consumption. Its lampshade is covered inside with an enamelled paint for a better reflection of light. FLEXIO 2.0, the lamp with a slender and dynamic design, can be swivelled in all directions thanks to its flexible arm.

FLEXIO 2



- **Flexible adjustment:** Thanks to its flexible arm, the lamp has a great flexibility of adjustment in all directions to adjust the lighting in the right place on your worktop.
- **Robustness:** thanks to its thick sheet base, this all metal lamp, with beautiful finishes.
- **Optimum and bright lighting:** Its luminous intensity of 400 lumens offers a light without glare, uniform and which does not attack your eyes.
- **Sobriety and modernity:** lamp with slender and dynamic design with intuitive handling.
- **Available in 2 colors:** covered with a resistant EPOXY paint, this lamp comes black and grey metal.
- **ON / OFF switch:** easy to access on the cord

Warranty: 2 years

Maximum height: 47 cm / minimum height: 36.5 cm

Materials: head and pedestal in metal with EPOXY paint / metal arm



End user replaceable light source (LED only)

Characteristics

Measurement in Lux on the worktop in top view at 35 cm:

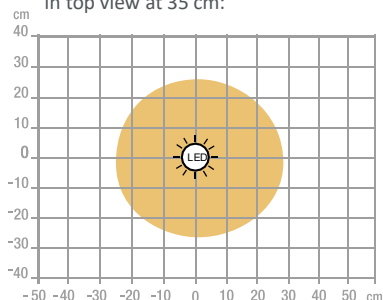

> 500 Lux

< 500 Lux

Measurement in Lux on the worktop in profile view at 35 cm:

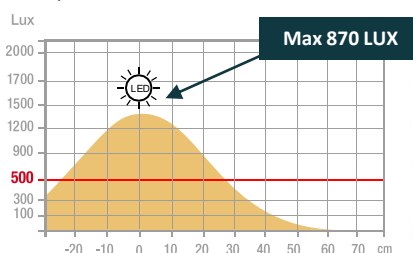

Measurement in nanometers of the light spectrum

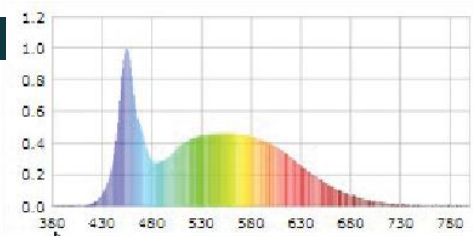

- 0 No-risk
- 1 Low-risk
- 2 Moderate-risk
- 3 High-risk

SAP no.	400093687	400093692
EAN code	3595560014750	3595560014781
Colors	Black	Grey Metal
Luminous flow	594	594
Lux at 35cm	870	870
Lm/W	119	119
Color T° (K)	3000	3000
CRI	83	83
Source Lifetime (h)	30 000	30 000
Energy consumption (kWh/1000 h)	5	5
USB Port	No	No
Inductive charger	No	No
Net weight (kg)	0,92	0,92

OUR CSR COMMITMENTS

1. All our lighting are **100% repairable** thus limiting planned obsolescence.
2. Reduce our carbon footprint through our **ECO-DESIGN THINKING** approach.
3. Contribute to the preservation of the planet's natural resources by promoting the use of **recycled materials**.
4. Optimize our packaging to control our **transport costs**.
5. Highlight the **talent of our employees** by ensuring social equality.

Energy class

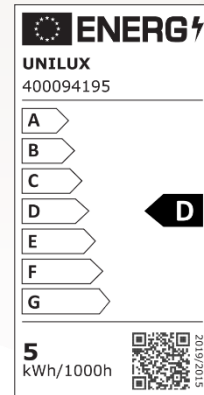

OUR EXPERTISE

1-Why use auxiliary lighting?

We are regularly subjected to constant artificial lighting in the office, which takes no account of our biological rhythms. Poor lighting quality can cause headaches, sleep disorders and loss of concentration. According to a recent study, only 34% of offices achieve the level of illumination of 500 lux recommended by Occupational Medicine in accordance with DIN EN 12464-1*.

2-How to light your workspace?

- Position the lamp head at least 35 cm above the worktop. work surface.
- Place the lamp on the opposite side to the hand that is holding the mouse or writing.
- Use lamps with asymmetrical lighting to reduce eyestrain, which can lead to eye irritation, headaches, loss of concentration, reduced productivity, etc.
- Position the lamp so that it is easy to adjust and so that the light is in the right place.
- Avoid reflections from shiny surfaces.
- Limit direct glare from bright light in the field of vision and indirect glare from bright light in the field of vision. in the field of vision and indirect glare from the reflection of light from the reflection of light in the field of vision, on a work surface walls or objects.

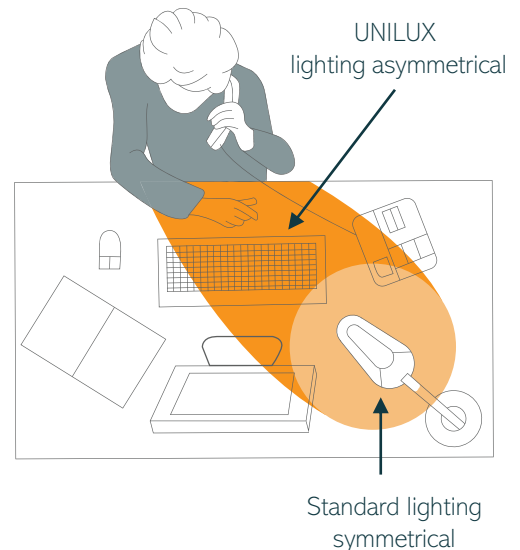

OUR CERTIFICATIONS





Unilux is committed to an eco-responsible approach and ensures that its products respect this commitment. Indeed, we are very concerned about current environmental issues and we aspire to respond as best as possible to the concerns of our consumers on this subject. Sustainable development is at the heart of our strategy and we act for the environment. You will find below the different certifications that Unilux has and that prove its environmental commitment.







UNILUX

* DIN EN 12464-1 (DIN 5035-1): European standard which determines the lighting requirements for workstations in closed places, these satisfying the needs of comfort and visual performance. DIN EN 12464-1 replaced DIN 5035-1

USER GUIDE

  x1  1 min 

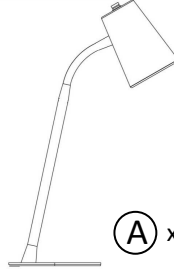
 www.my-unilux.com

  (A) x1  (B) x1 (E14 5W)

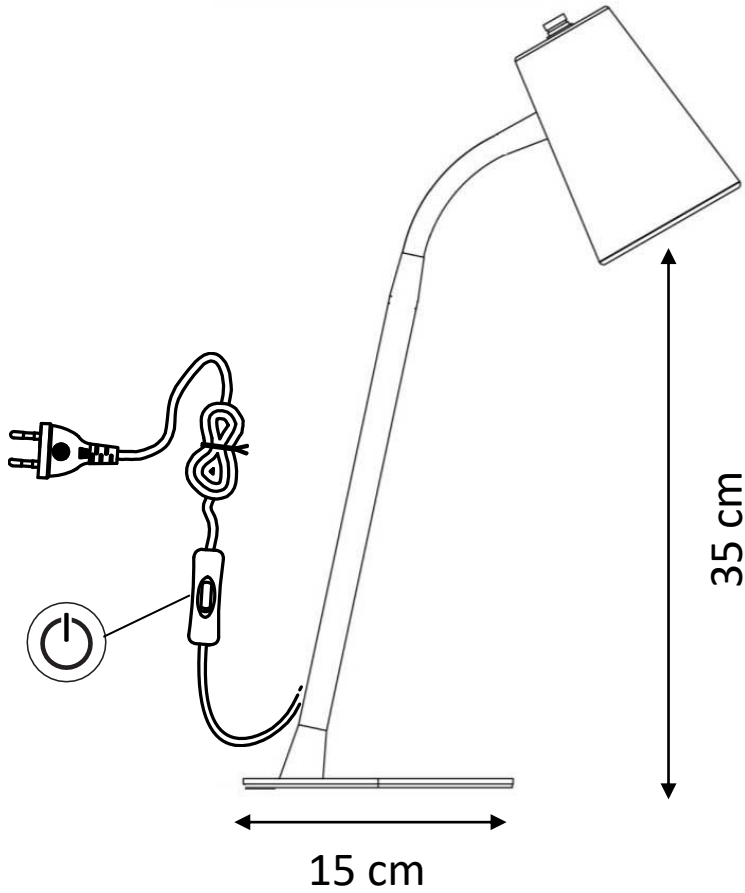

E14 max 8W

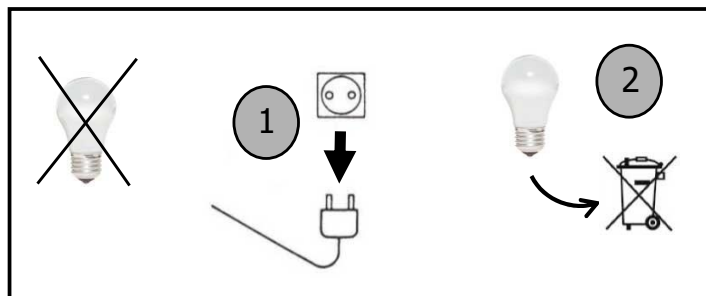

30 products available on pCon Planner

You will be able to obtain data on many UNILUX or OFML standard products and integrate them quickly and easily into 3D space layouts via pCon.



Download on our E-shop

Always available: photos in HD, data sheets, instruction manual, repairability instructions for all our products.



Do you have any questions?

Our after-sales service is always at your disposal

Tèl: +33 1 81 86 06 03

E-mail: contact.unilux@hamelinbrands.com

17 avenue du Parc TECHNOPOLES

91380 Chilly Mazarin – France

Tèl: +33 1 81 86 06 00

www.my-unilyx.com

E-mail: contact.unilux@hamelinbrands.com

UNILUX