





i

5 min



x 1



www.my-unilux.com

+



x3



x1



x1





x1



x1

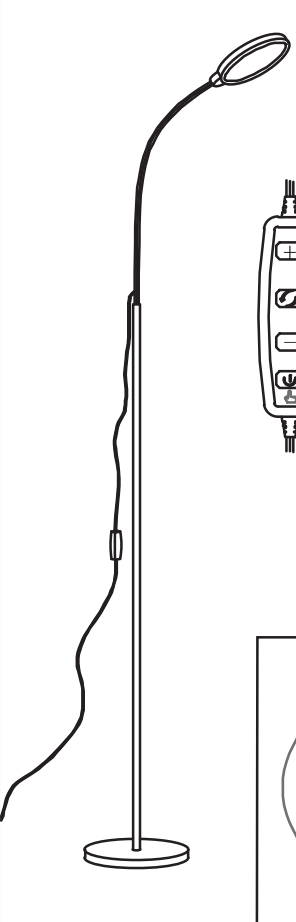

x1

- Increase the brightness
- Adjust the color of light
- Reduce the brightness
- Turn ON/OFF Light

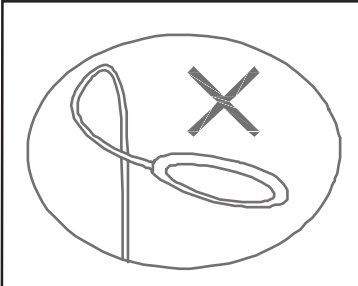

1

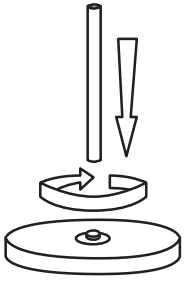

2

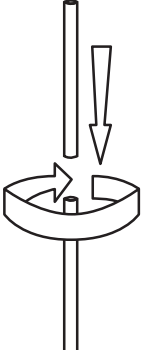

3

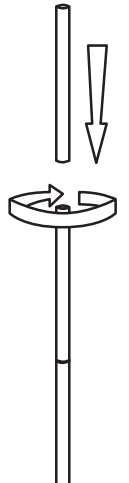

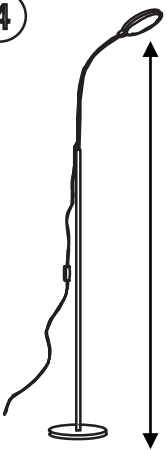

4



150 cm

Differents positions



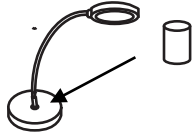

Uplighter positions





Desk lamp positions

UK : If the outer soft cable or the wire is damaged, it must be replaced exclusively by the manufacturer, his service department or any person of similar qualification, in order to avoid any risk.

 LED light. Do not stare into beam. The light source of this luminaire is not replaceable; when the light source reaches its end of life the whole luminaire shall be replaced.

DE : Sollte das äußere Kabel oder die innere Leitung dieser Leuchte beschädigt sein, darf es ausschließlich nur vom Hersteller, seinen Wartungstechnikern oder von qualifiziertem Personal ausgetauscht werden, um jegliche Risiken zu vermeiden.

 LED-Leuchte. Nicht in den Lichtstrahl schauen. Die Lichtquelle dieser Leuchte ist nicht ersetzbar; wenn die Lichtquelle ihr Lebensdauerende erreicht hat, ist die gesamte Leuchte zu ersetzen.

NL : Indien de buitenkant van de kabel is beschadigd, dient deze te worden vervangen door de fabrikant, zijn servicedienst of een persoon van vergelijkbare kwalificatie, om elk risico te vermijden.

 LED lamp. Niet langdurig in de lamp kijken. De lichtbron van deze lamp kan niet vervangen worden. Als de lichtbron het einde van zijn levensduur bereikt heeft, dient men de complete lamp te vervangen.

FR : Si le câble extérieur souple ou le cordon de ce luminaire est endommagé, il doit être remplacé exclusivement par le fabricant, son service de maintenance ou toute personne de qualification équivalente, ceci afin d'éviter tout risque.

 Lumière LED. Ne pas fixer directement le rayon lumineux. La source lumineuse de ce luminaire n'est pas remplaçable ; lorsque la source lumineuse atteint sa fin de sa vie, le luminaire entier doit être remplacé.

ES : Si el cable exterior flexible o el cordón de este alumbrado se dañan, debe ser sustituido exclusivamente por el fabricante o su servicio de mantenimiento o toda persona de calificación equivalente, esto con el fin de evitar todo riesgo.

 Luz LED. No mirar fijamente al haz. La fuente de luz de esta lámpara no se puede reemplazar; cuando la fuente de luz llega al final de su vida, se debe reemplazar la lámpara entera.

PT : Se o cabo exterior ou o fio estiverem danificados, os mesmos devem ser substituído exclusivamente pelo fabricante, pelo seu serviço técnico ou uma pessoa devidamente qualificada para o efeito, a fim de se evitar qualquer risco.

 Luz LED. Não olhe directamente para a mesma. A fonte luminosa deste candeeiro não é substituível; quando a fonte luminosa tiver alcançado o seu fim de vida útil, tem de ser substituído todo o candeeiro.

IT : Se il cavo elettrico esterno o il cablaggio di questa lampada è danneggiato deve essere sostituito esclusivamente dal produttore, dal proprio servizio di manutenzione o da persone con qualificazione adeguata, questo per evitare qualsiasi rischio.

 Luce prodotta da LED. Non fissare direttamente il fascio luminoso. La sorgente luminosa di questo apparecchio di illuminazione non è sostituibile; quando la sorgente luminosa giunge al termine, è necessario sostituire l'intero apparecchio di illuminazione.

SE : Om sladden är skadad måste den bytas ut av tillverkaren, dennes serviceavdelning eller en person med liknande kvalifikationer, för att undvika eventuella risker.

 LED-ljus. Titta inte in i ljustrålen. Ljuskällan i denna armatur är inte utbytbar, när ljuskällan når slutet av sin livslängd måste hela armaturen ersättas.

FI : Mikäli liitäntäjohto tai kaapelin eriste rikkoutuu, kaikkien riskien välttämiseksi ne on vaihdettava valmistajalla, hänen valtuuttamalla huollolla tai henkilöllä jolla on vastaava osaaminen.

 LED-valo. Älä katso suoraan valosäteeseen. Valonlähteen tämän valaisimen ole vaihdettavissa silloin, kun valonlähde on lopussa elämän koko valaisimen ilmauksella.

NO : Om ledningen er skadet, må den kun erstattes av produsent, produsentens serviceavdeling eller av personell med tilsvarende kompetanse for å unngå risiko.

 LED lampe. Ikke se rett inn i lyskilden. Når lyspæren er utbrent, må hele lampen erstattes.

PL : Jeżeli zewnętrzny przewód elektryczny ulegnie uszkodzeniu, w związku z niebezpieczeństwem porażenia prądem jego wymiany może dokonać jedynie producent, jego przedstawiciel serwisowy lub inna wykwalifikowana osoba.

 Uwaga: oświetlenie LEDowe. Nie patrzeć prosto w światło. Źródło światła w tym oświetleniu jest niewymienne; gdy źródło światła osiągnie koniec okresu użytkowania, należy wymienić całe oświetlenie.