

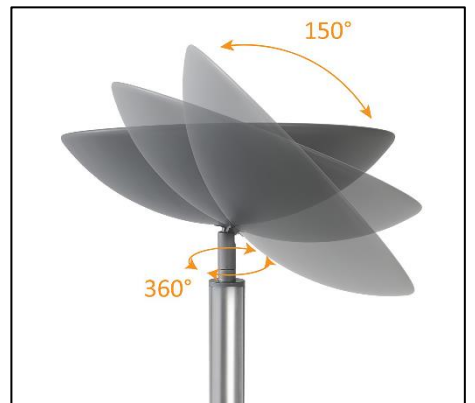

UNILUX

DELY 2.0

DELY 2.0



DELY 2.0 articulated



DELY 2.0



- **Easy to use:** its dimmer located on the mast allows you to find the most comfortable lighting for reading, writing and working.
- **Soft and modern design:** its finesse and sober lines will bring a modern look to your office.
- **Longevity:** the lifespan of its LEDs is estimated at more than 40,000 hours.
- Uniform light diffusion: indirect lighting without glare, you will benefit from quality accent lighting.
- **Available in two colors:** black or metal gray
- **Available in two versions:** straight mast or articulated mast

Warranty: 2 years

Height: 183 cm (straight mast version)

Maximum height: 186 cm/ minimum height: 174 cm (articulated mast version)

Head: Ø 28 cm

Materials: Superior quality all-steel with Epoxy paint finish



Professional replaceable light source (LED only)

Characteristics

Lux measurement upwards 35 cm from the light source:

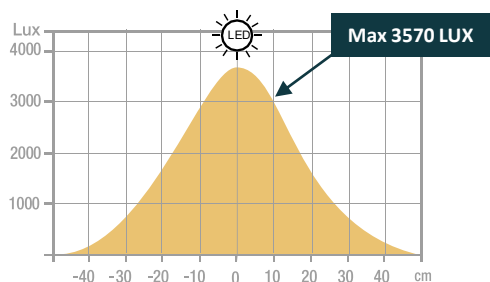

Measurement in nanometers of the light spectrum

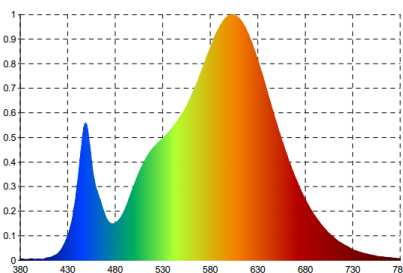

SAP. code	400153721	400153720	400153698	400153697
EAN code	3595560031832	3595560031818	3595560031771	3595560031757
Colors	Black	Metal grey	Articuled black	Articuled metal grey
Luminous flow (Lm)	3041	3041	3041	3041
Lux at 55 cm (indirect)	3570	3570	3570	3570
Luminous Efficiency (Lm/W)	132	132	132	132
Color T° (K)	3000	3000	3000	3000
CRI	82	82	82	82
Source's lifetime (h)	40 000	40 000	40 000	40 000
Energy Consumption (kWh/1000h)	23	23	23	23
Net weight (kg)	8,27	8,27	8,27	8,27

OUR CSR COMMITMENTS

1. All our lighting are **100% repairable** thus limiting planned obsolescence.
2. Reduce our carbon footprint through our **ECO-DESIGN THINKING** approach.
3. Contribute to the preservation of the planet's natural resources by promoting the use of **recycled materials**.
4. Optimize our packaging to control our **transport costs**.
5. Highlight the **talent of our employees** by ensuring social equality.

Energy class

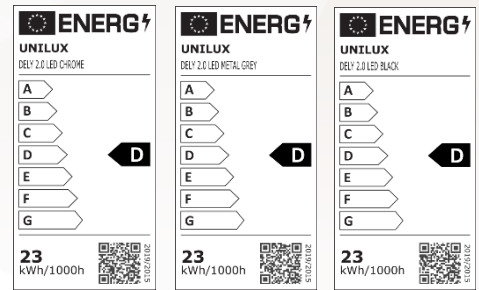

OUR EXPERTISE

1- Floor lamp with direct and indirect lighting: the ideal and optimal lighting on your desk

Because they're so easy to install and so decorative, indirect-lighting floor lamps are a firm favourite with the French! This floor lamp is ideal for illuminating a specific area of a room, or for adding a small, original decorative touch that will change the whole atmosphere of the room.

Thanks to its upward-directed light, which will reverberate off the ceiling, this floor lamp generally acts as a secondary or ambient light, providing you with high quality, high-performance lighting. It blends in perfectly with any room in your business:

- individual office
- open space
- meeting rooms
- high-traffic areas such as reception halls

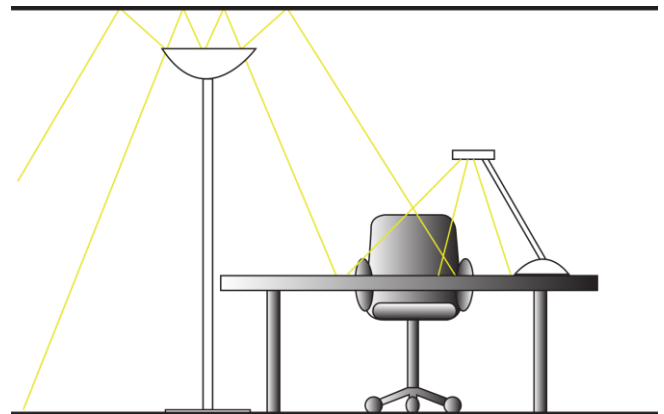

Lighting according to DIN EN 12464-1 * for the office

- **300 Lux:** deposit, copy, circulation areas
- **500 Lux:** writing, reading, data processing
- **500 Lux:** at the reception and at the counter
- **750 Lux:** technical drawing

OUR CERTIFICATIONS

Unilux is committed to an eco-responsible approach and ensures that its products respect this commitment. Indeed, we are very concerned about current environmental issues and we aspire to respond as best as possible to the concerns of our consumers on this subject. Sustainable development is at the heart of our strategy and we act for the environment. You will find below the different certifications that Unilux has and that prove its environmental commitment.



* DIN EN 12464-1 (DIN 5035-1): European standard which determines the lighting requirements for workstations in closed places, these satisfying the needs of comfort and visual performance. DIN 12464-1 replaced DIN 5035-1

USER GUIDE

i

x1

5 min

www.my-unilux.com

Turn to increases or decreases the brightness

174-186 cm

25 cm

Turn to increases or decreases the brightness

182 cm

25 cm

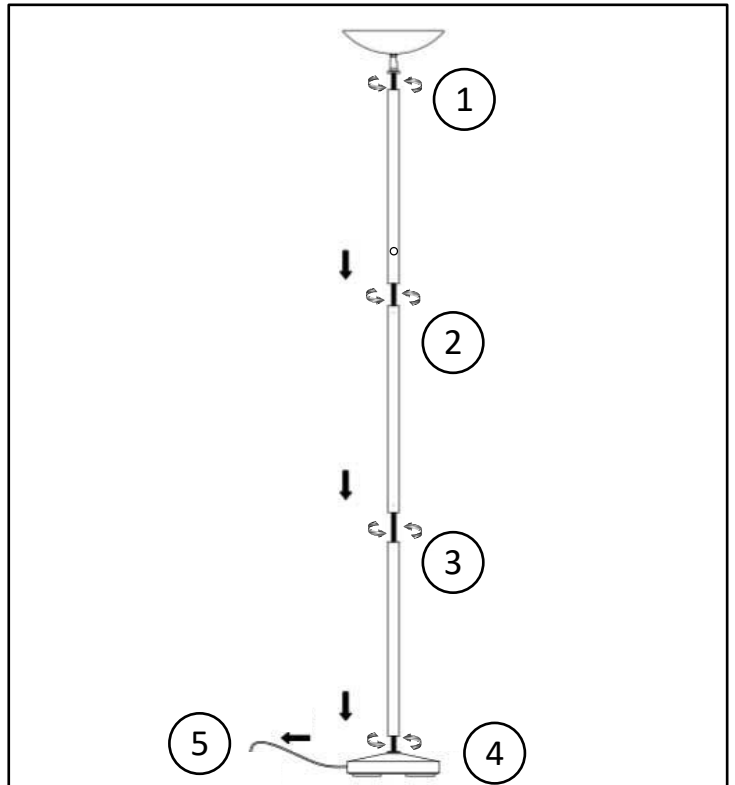
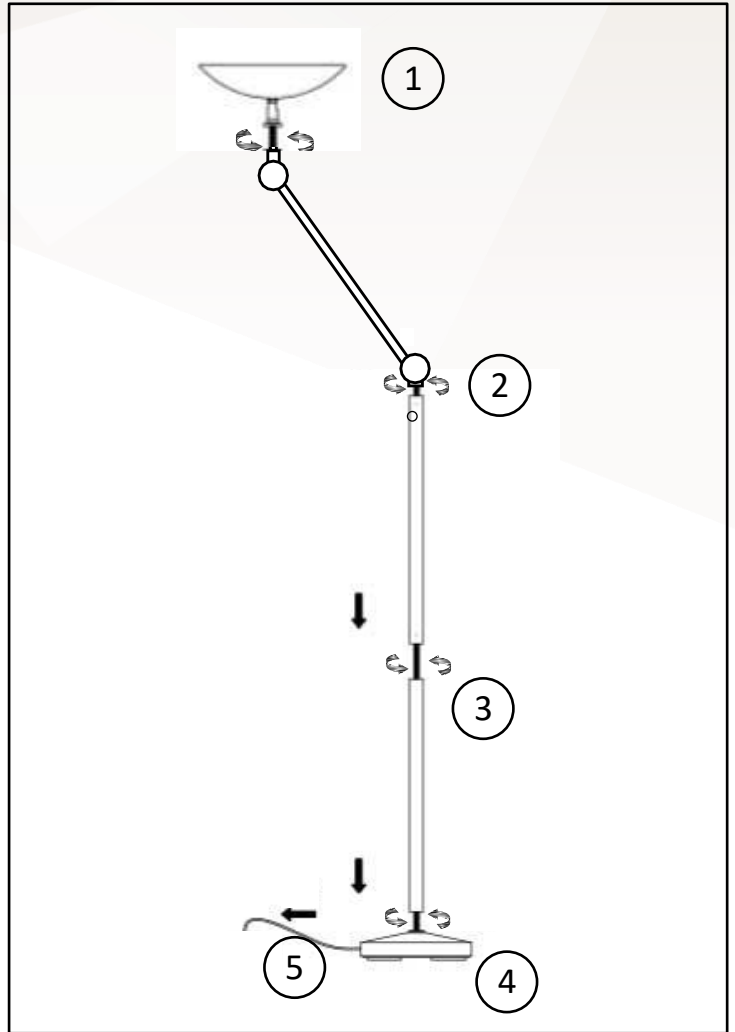

30 products available on pCon Planner

You will be able to obtain data on many UNILUX or OFML standard products and integrate them quickly and easily into 3D space layouts via pCon.



Download on our E-shop

Always available: photos in HD, data sheets, instruction manual, repairability instructions for all our products.



Do you have any questions?

Our after-sales service is always at your disposal

Tèl: +33 1 81 86 06 03

E-mail: contact.unilux@hamelinbrands.com

17 avenue du Parc TECHNOPOLES

91380 Chilly Mazarin – France

Tèl: +33 1 81 86 06 00

www.my-unilyx.com

E-mail: contact.unilux@hamelinbrands.com

UNILUX